





# MOTORSCHUTZPLATTE EXTREME

Engine protection plate Extreme | Plaque de protection moteur Extreme | Placa de protección del motor Extreme | Piastra protezione motore Extreme

Art.-Nr: **71221-002**

## LEGENDE/KEY/FILE LÉGENDE

-  **Anbau Tipp**  
Fitting tip  
Astuce de montage
-  **Achtung**  
Attention  
Attention
-  **Vergrößerung**  
Magnification  
Grossissement
-  **Montagepaste**  
Fitting lubricant  
Lubrifiant de montage

-  **Schraube**  
Screw  
Vis
-  **Schraubensicherung**  
Thread locking fluid  
Freinfiets
-  **Drehmoment**  
Torque  
Torque
-  **Reiniger**  
Cleaner  
Nettoyant

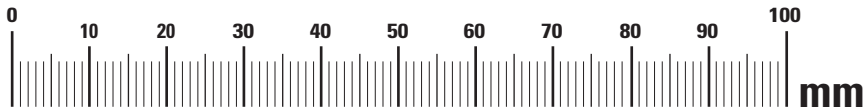
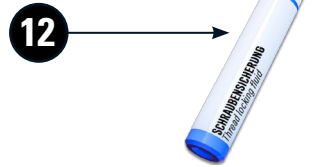

#	Bauteil <i>component</i> <i>composant</i>	DE Die Farben der Abbildungen dienen nur der Veranschaulichung. EN The colors are for illustrating purposes only. FR Les couleurs utilisées sont à titre indicatif seulement.	DIN	ISO	Menge <i>quantity</i> <i>quantité</i>	
1	U-Scheibe / Washer		M12	125	7089	2
2	Stufenhülse / Stepped bushing					2
3	Gummischeibe / Rubber washer					4
4	Zylinderkopfschraube / Cylinder head screw		M12x25	912	4762	2
5	Kabeltülle / Cable grommet					2
6	Linseflanschschraube / Lens flange screw		M8x20	7381	7381	2
7	Stufenhülse / Stepped bushing					2
8	U-Scheibe / Washer		M5	125	7089	1
9	Senkkopfschraube / Countersunk screw			7991	10642	1
10	Rohrschelle / Pipe clamp					1
11	Sechskantmutter / Hex nut		M5	985	10511	1
12	Schraubensicherung / Thread locking fluid					1

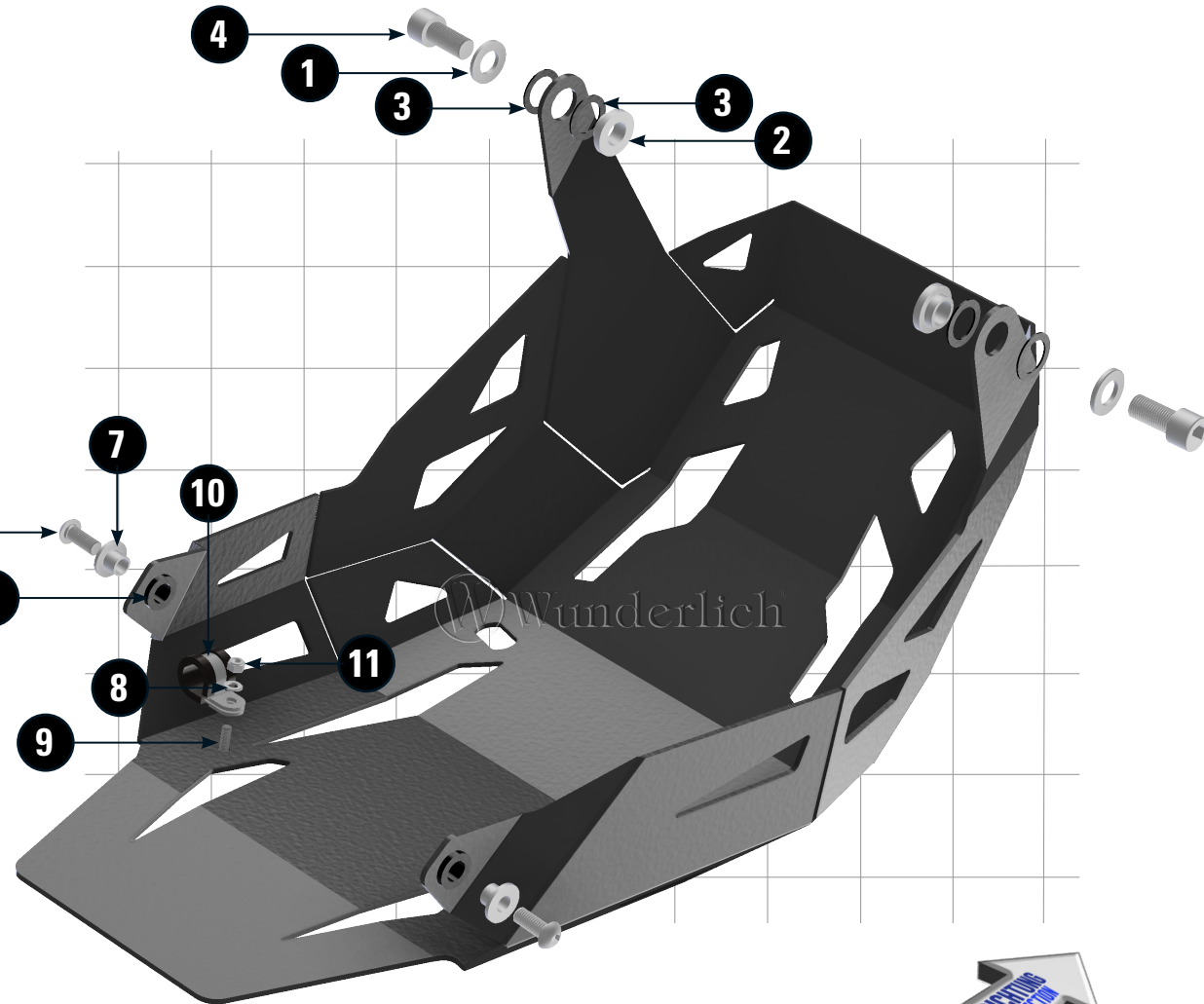

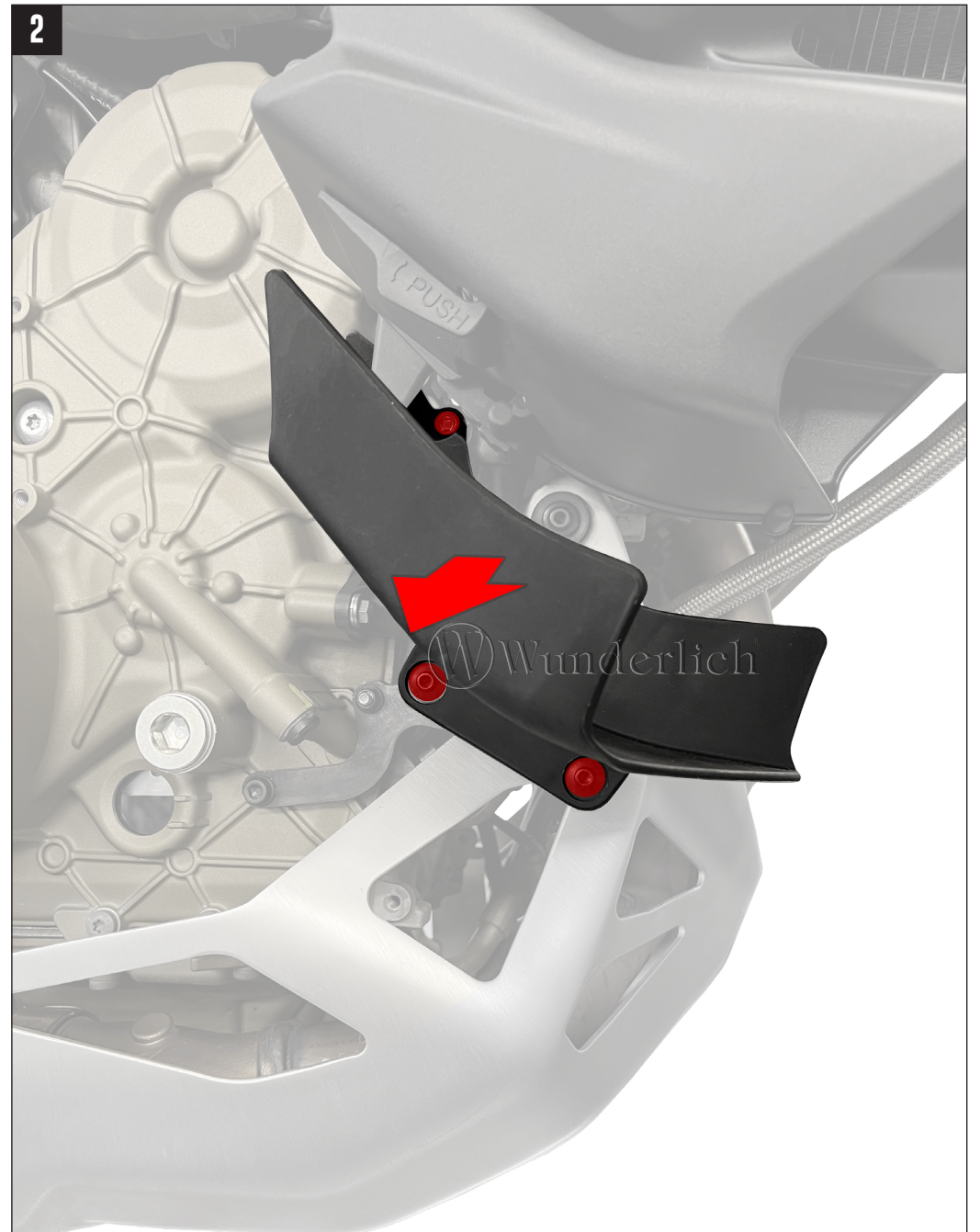
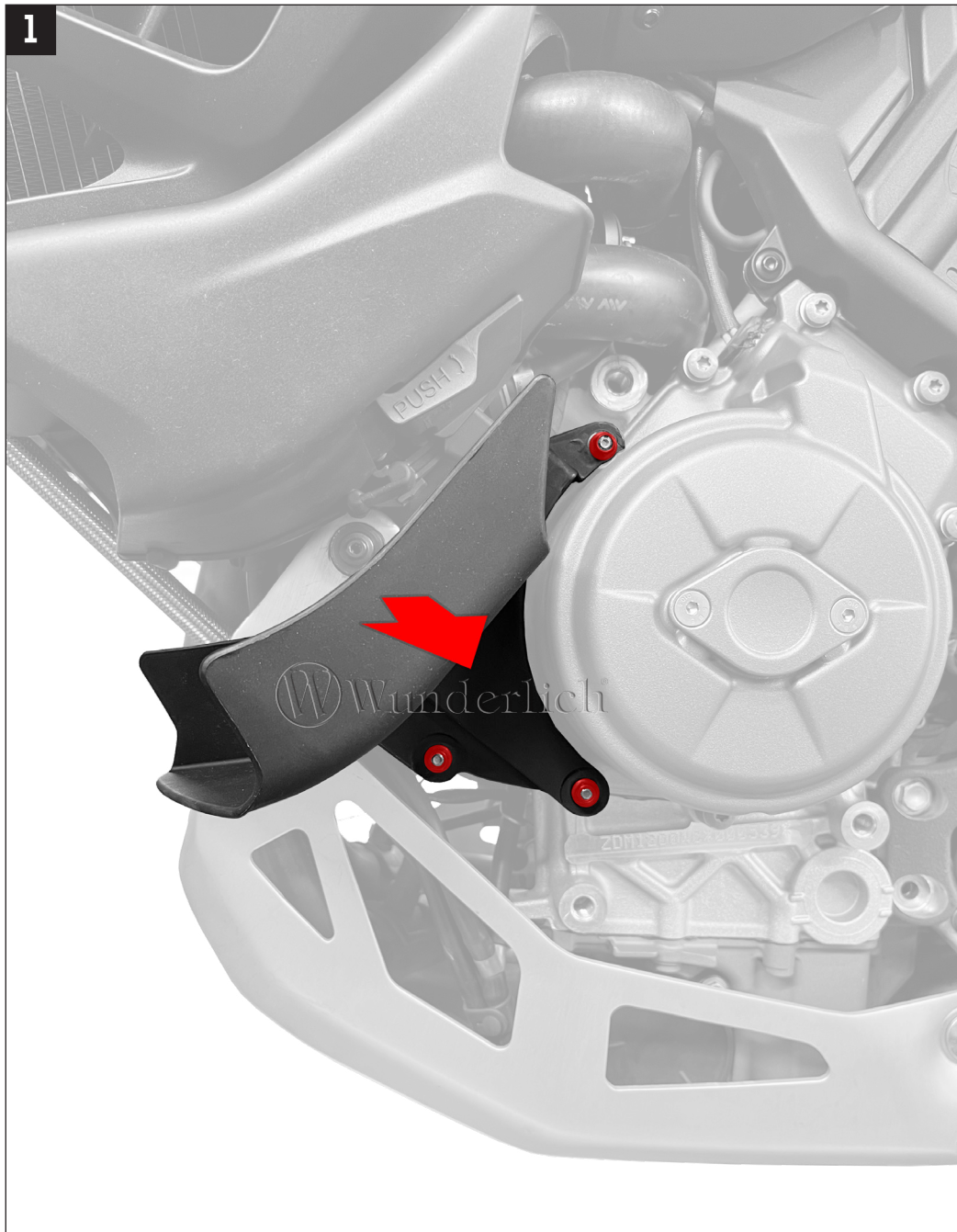



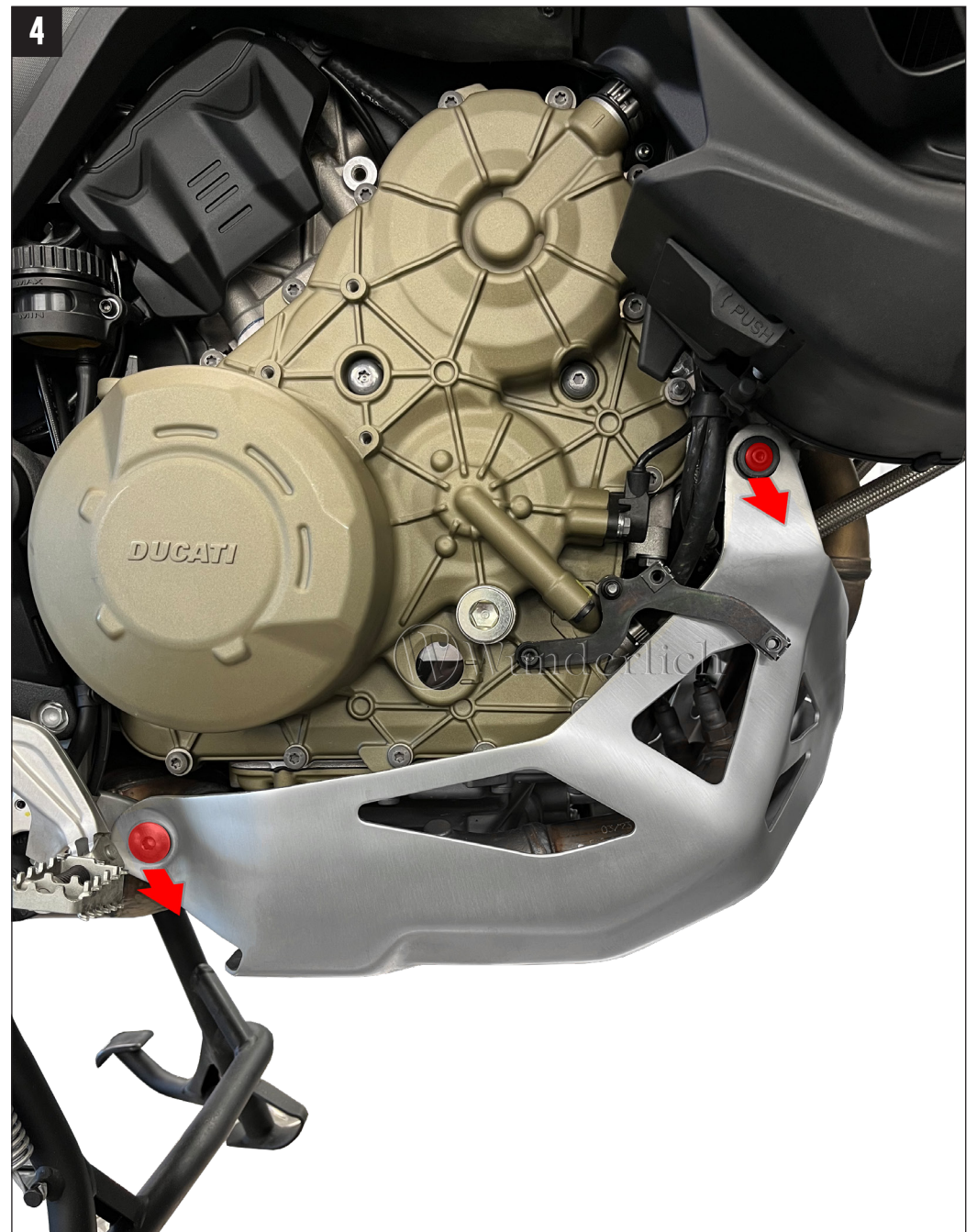
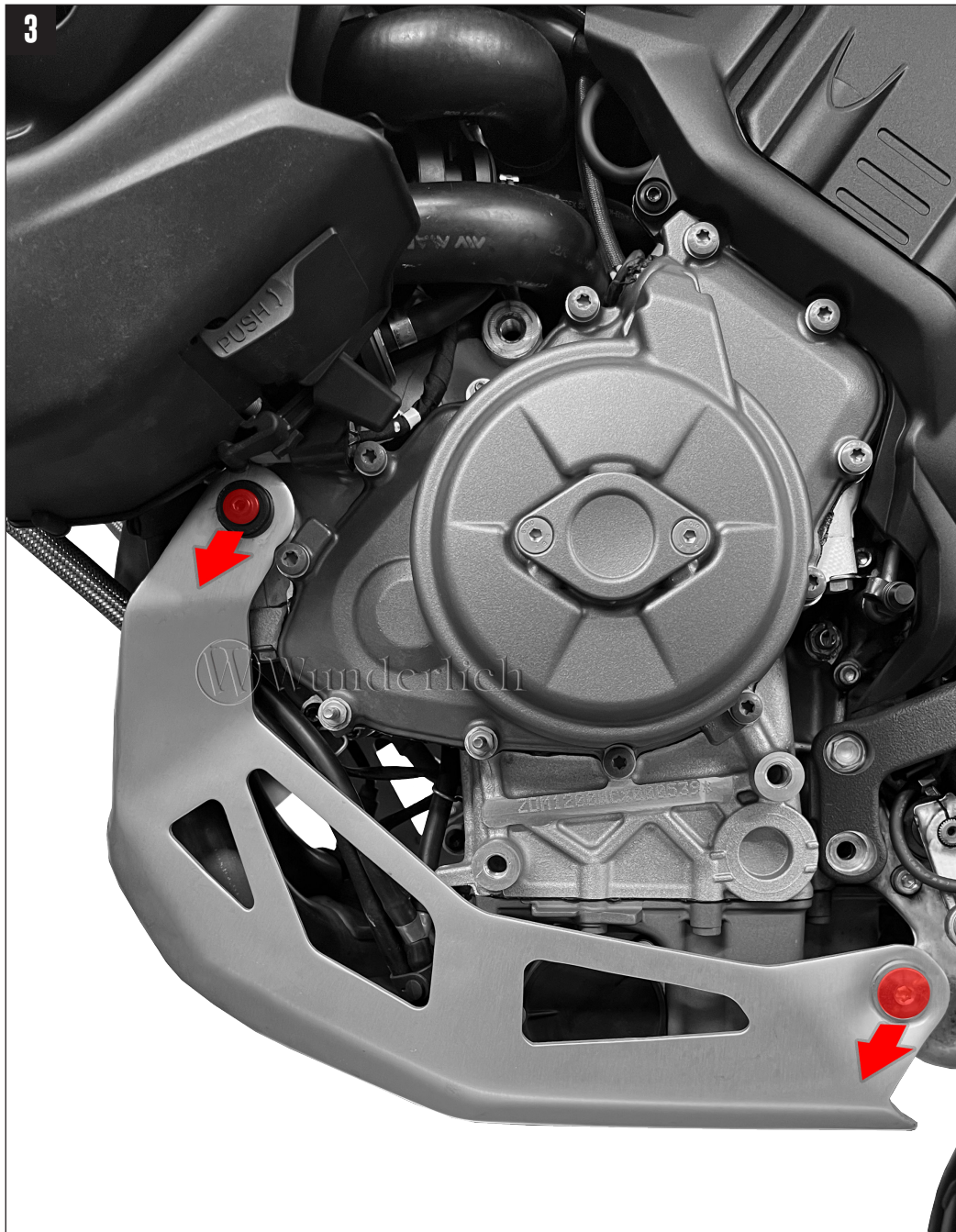



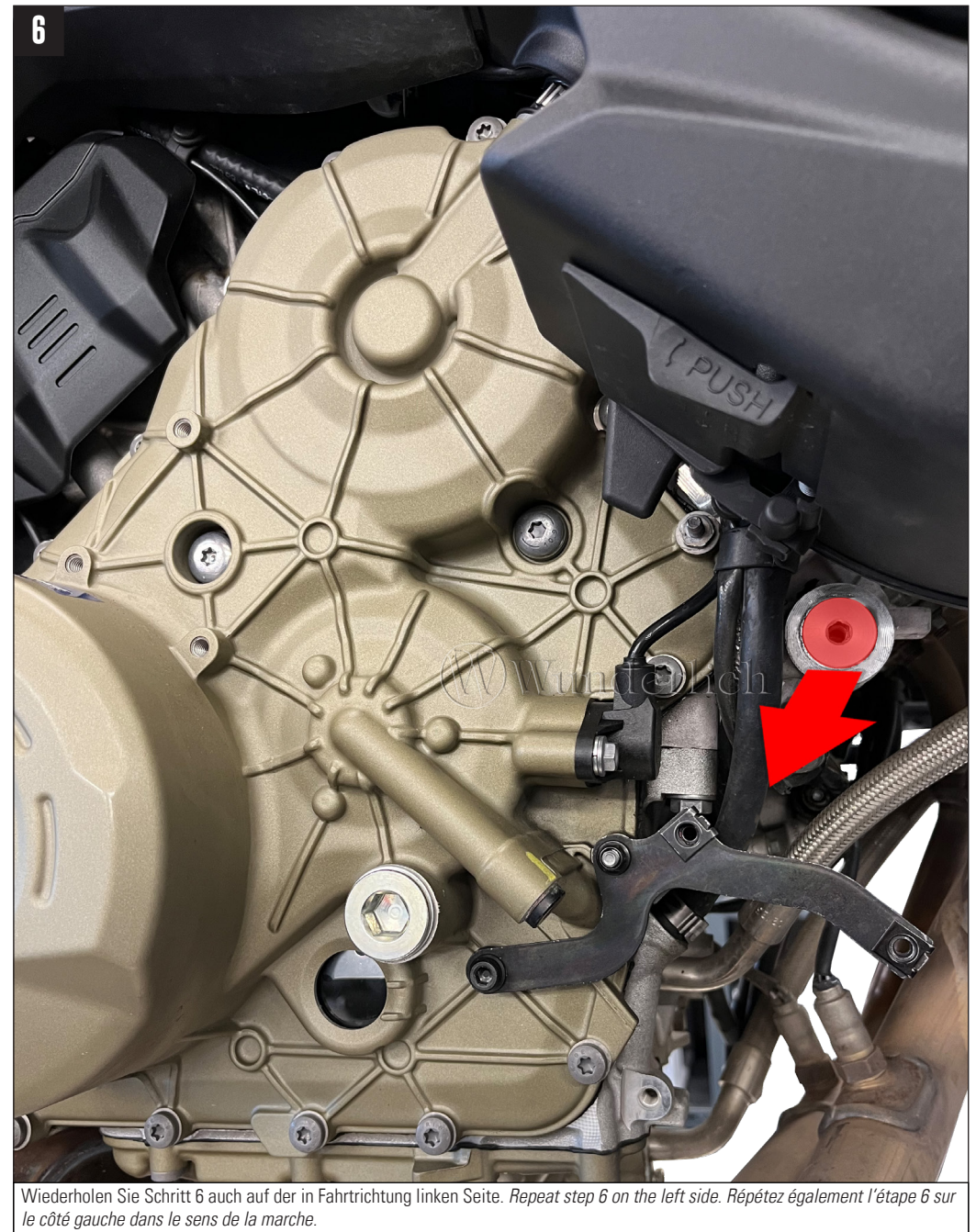

Wiederholen Sie Schritt 6 auch auf der in Fahrtrichtung linken Seite. Repeat step 6 on the left side. Répétez également l'étape 6 sur le côté gauche dans le sens de la marche.



7

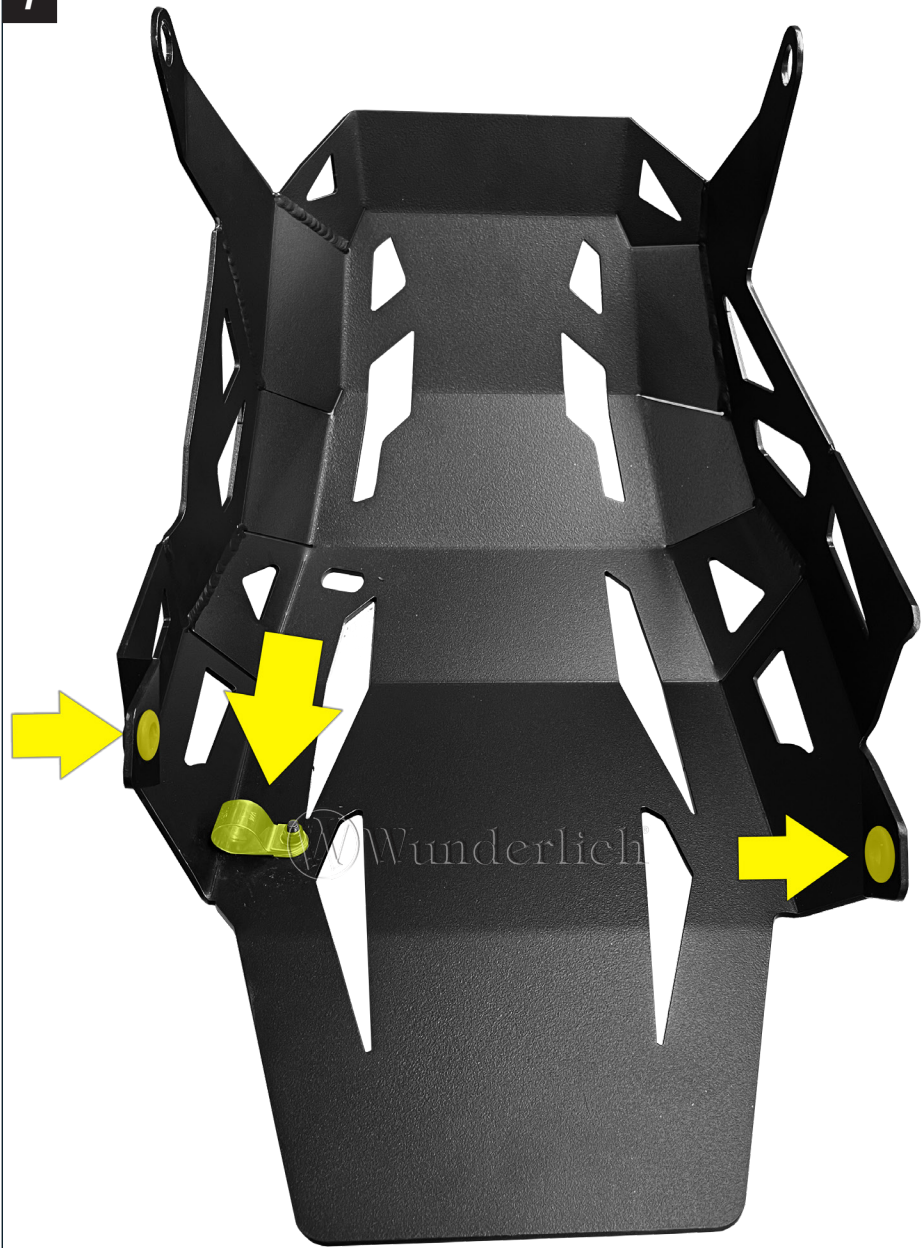

8

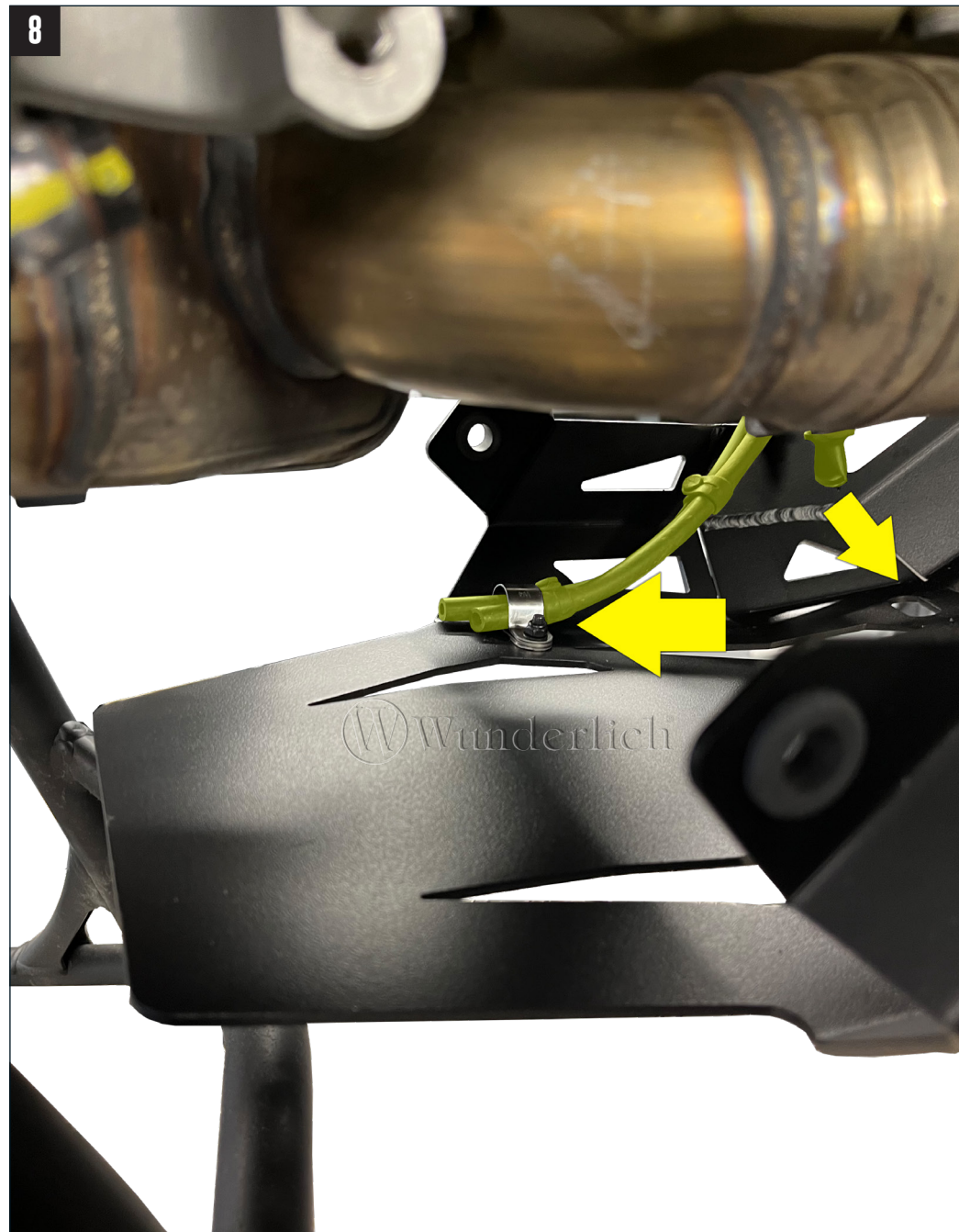



9

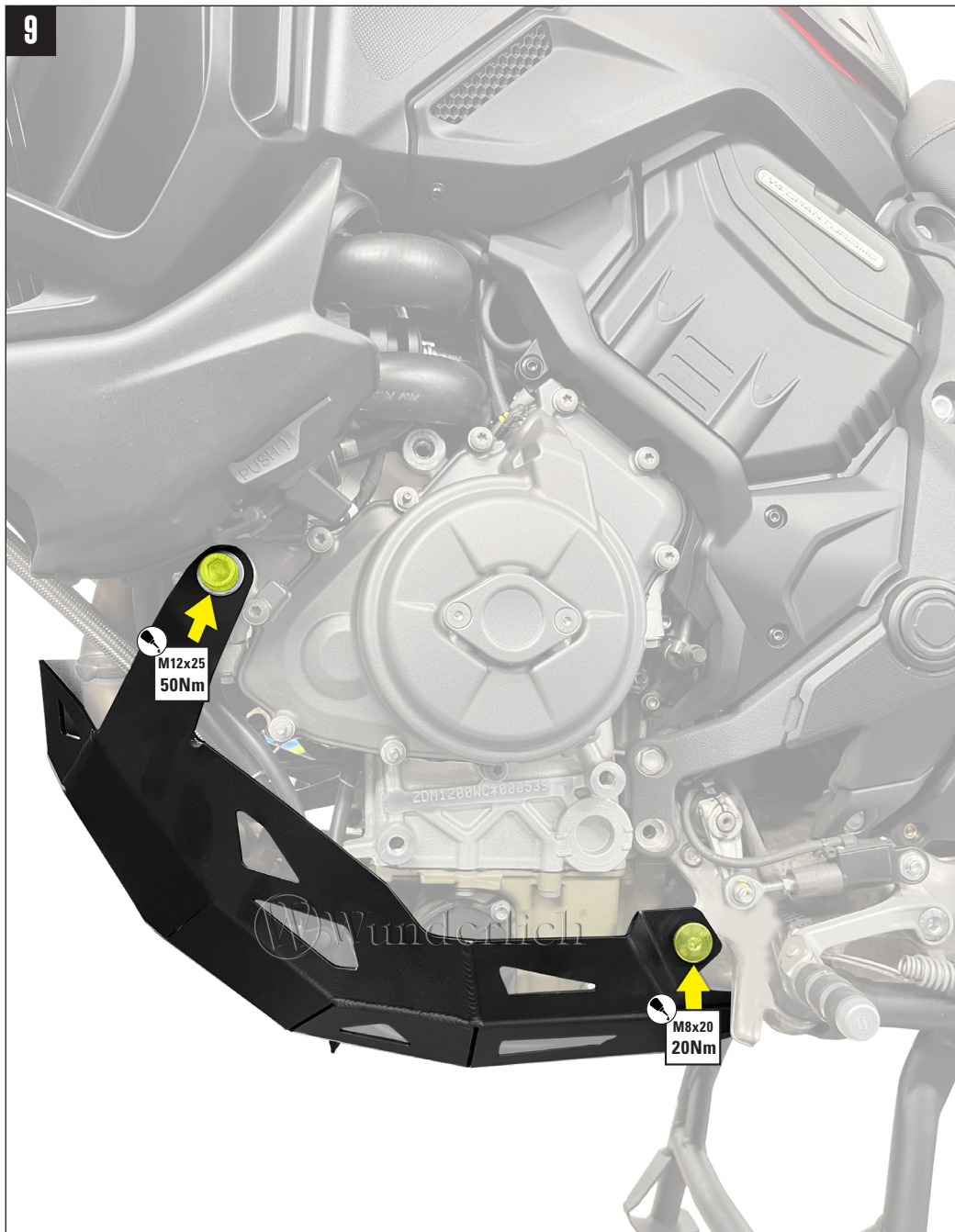

10

