

RAHMENABDECKUNG

Frame cover | Couverture de cadre | Cubierta de marco | Copertura del telaio

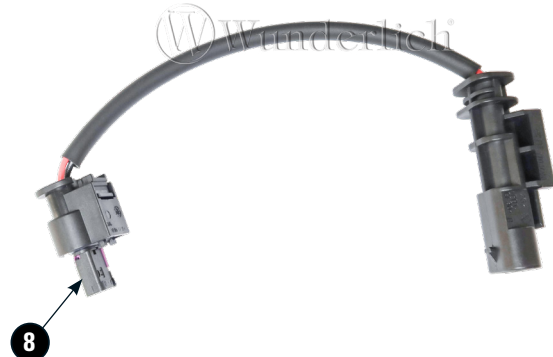





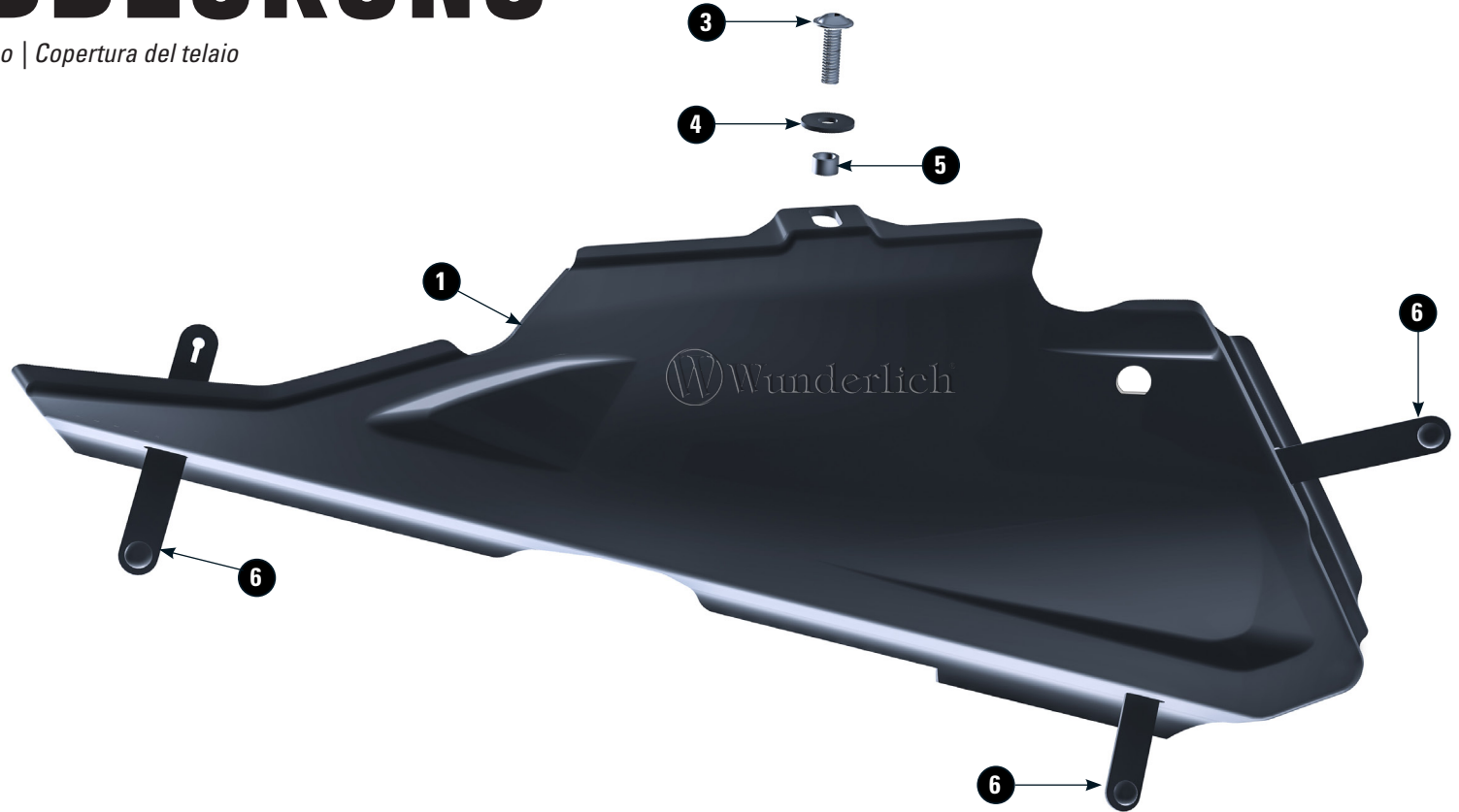

Art.-Nr: 20800-602/702/21X/22X



Kann bei Bedarf als Verlängerung genutzt werden.
Can be used as an extension if needed.
Peut être utilisé comme extension si nécessaire.



LEGENDE/KEY/FILE LÉGENDE

-  **Anbau Tipp**
Fitting tip
Astuce de montage
-  **Achtung**
Attention
Attention
-  **Vergößerung**
Magnification
Grossissement
-  **Montagepaste**
Fitting lubricant
Lubrifiant de montage
-  **Schraube**
Screw
Vis
-  **Schraubensicherung**
Thread locking fluid
Freiniflets
-  **Drehmoment**
Torque
Torque
-  **Reiniger**
Cleaner
Nettoyant

#	BEZEICHNUNG / DESCRIPTION	DE / EN / FR	Die Farben der Abbildungen dienen nur der Veranschaulichung. / The colors are for illustrating purposes only. / Les couleurs utilisées sont à titre indicatif seulement.	DIN	ISO	MENGE / QUANTITY
1	Rahmenabdeckung (rechts) / Frame cover (right side)					1
2	Rahmenabdeckung (links) / Frame cover (left side)					1
3	Linsenflanschschraube / lens head screw	M6x20	8 Nm	7381SA2	7381SA2	2
4	U-Scheibe / washer	M6		9021SA2	7093	2
5	Hülse / sleeve	5,5mm				2
6	Gummi-Kabelbinder / rubber zip ties	74mm				6
7	Lackschutzfolie/protection film	20cm				5
8	Kabelverlängerung / extension cable					1

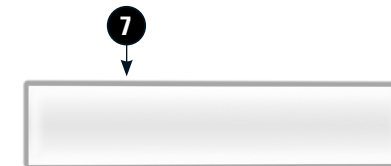

Anliegende Flächen am Rahmen mit Lackschutzfolie bekleben.
Cover points of contact with protection film.
Couvrir les points de contact avec un film de protection.



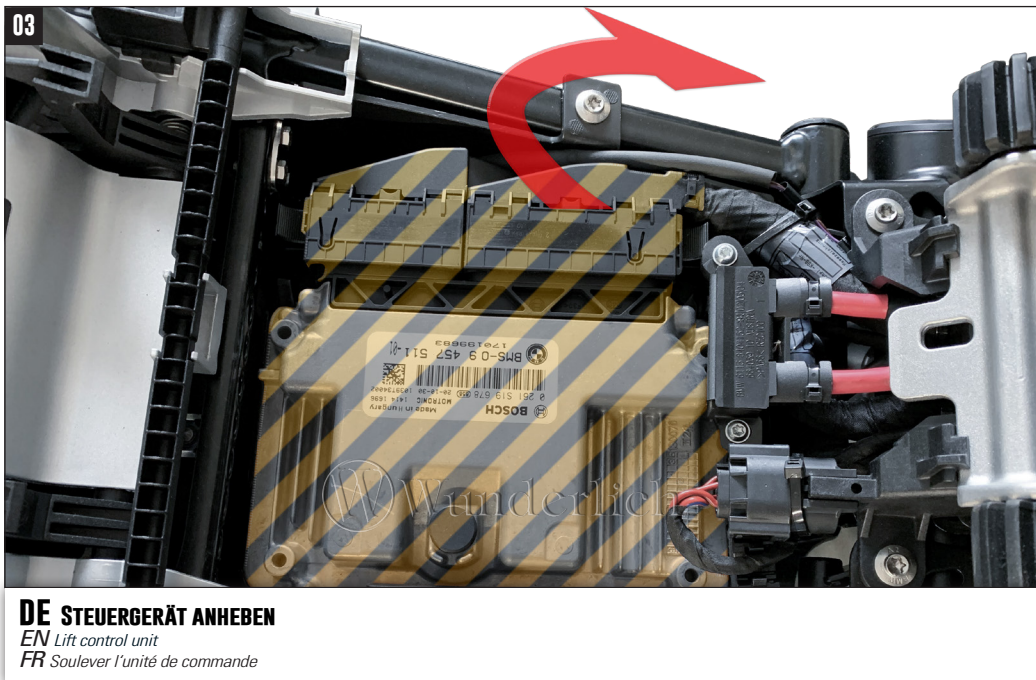
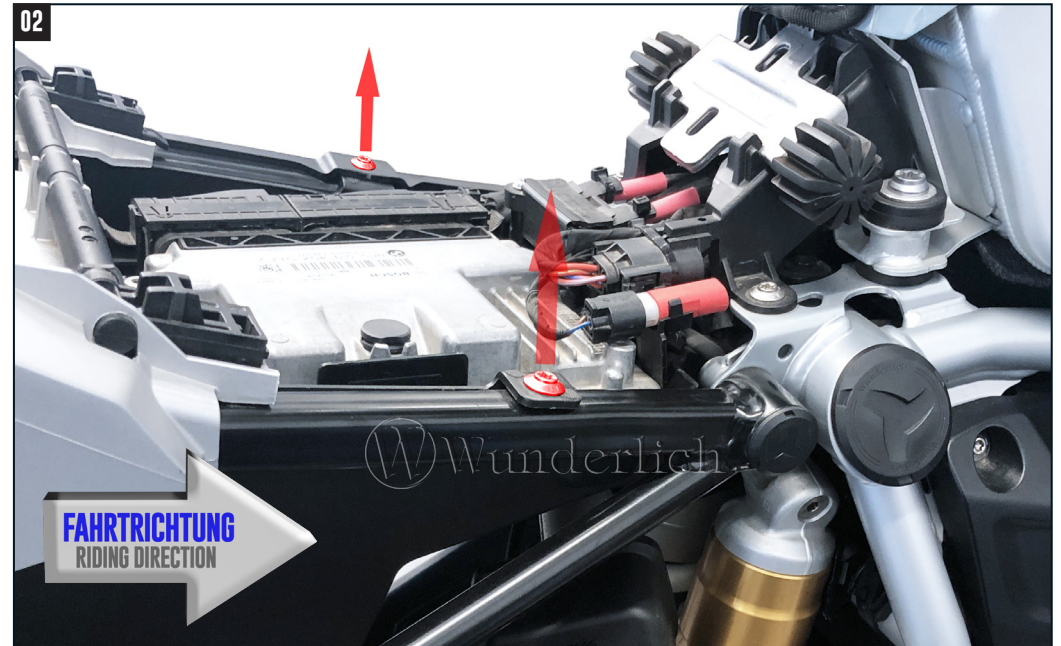
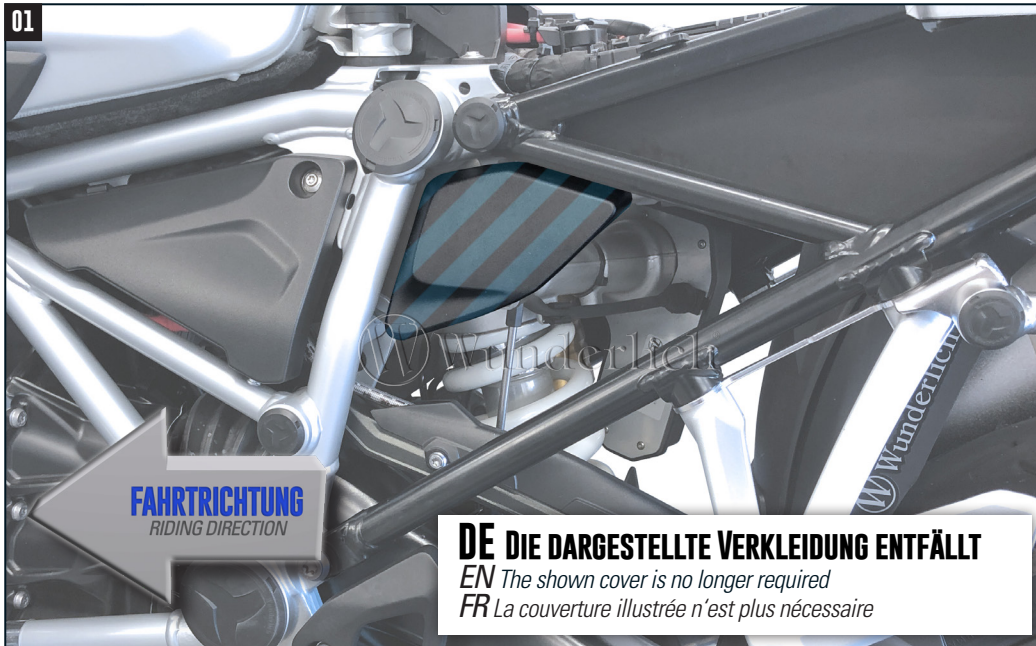

4.2

LINKS
left/gauche



05

RECHTS
right/droite

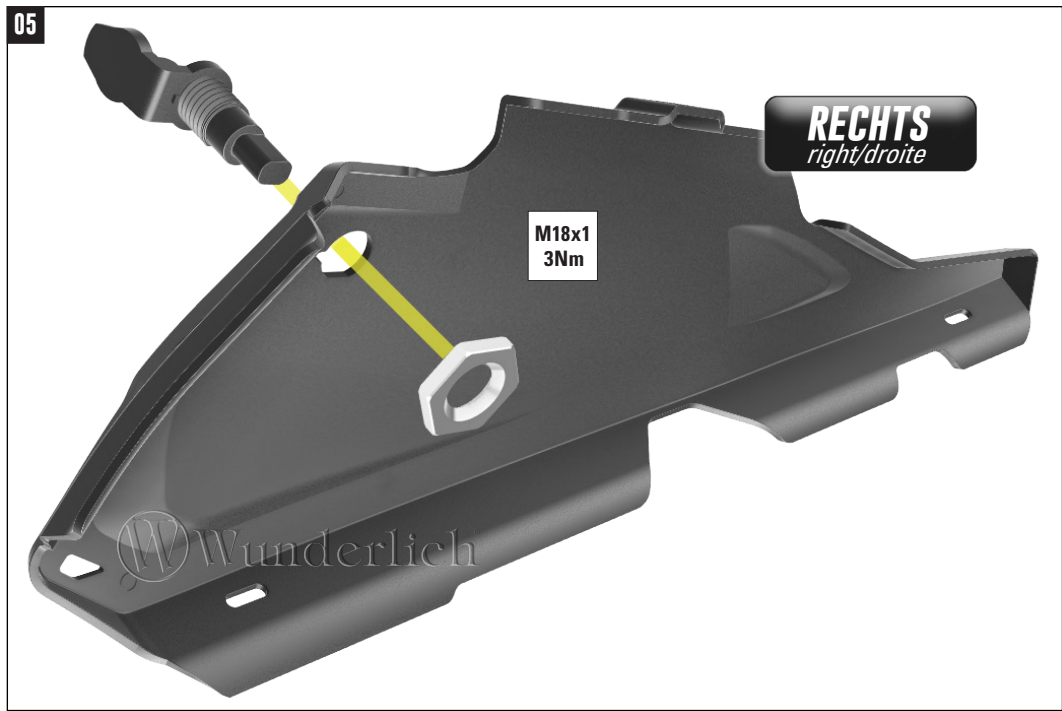

06

DE KABEL NACH RECHTS VERLEGEN & ANSCHLIEßEN

EN Lay cable to the right & connect

FR Posez le câble à droite et connectez-le



07

M6x20
8Nm

